

flexiguide

Product Specification

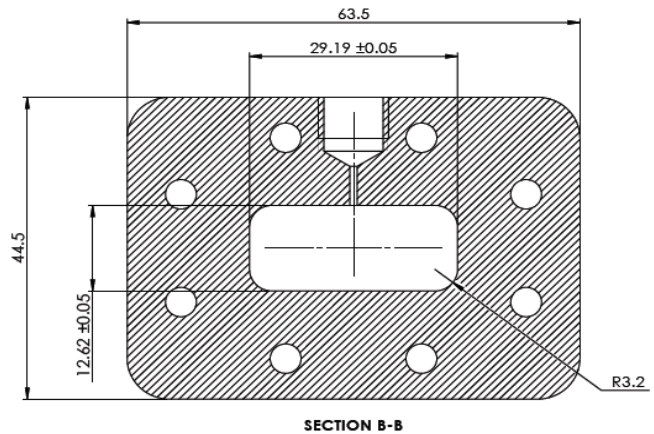
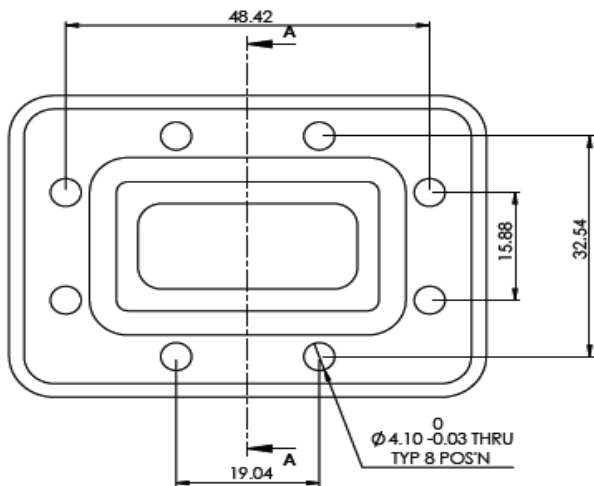

Part Number:

PI15H-P-*-FK

* = see options below

Description

Product Type:
Waveguide Size:
Flange Type:
Flange Material / Plating:
* Paint Finish:
Accessories:

Pressure Inlet
WG15 / WR112 / R84
15H (PDR84)
Aluminium / Passivation
G = Gray (RAL 7012), B = Black, W = White
Screws, Nuts, Washers, O-Ring(s) / Gasket(s)

Mechanical Specifications

Thread Size:
Thickness:
Gasket Groove Depth:

1/8" BSP (Parallel) - not compatible with NPT/NPS
16 mm / 0.6 inches
3.9 mm / 0.154 inches

Electrical Specifications

Frequency Range: 7.05 - 10.0 GHz
Insertion Loss: 0.04 dB
Return Loss: 34.2 dB

Environmental Performance

Temperature Range: -70 to +150°C
ETSI Class: ETSI EN 300-019-2-4 Class 4.1
I.P. Rating: IP65 (Weatherproof)