

flexiguide

Product Specification

Sealing Shims - metal waveguide shims with integrated rubber gaskets on both sides. Used for connecting two flat flange faces together in a rectangular waveguide system to create a pressure tight/waterproof joint.

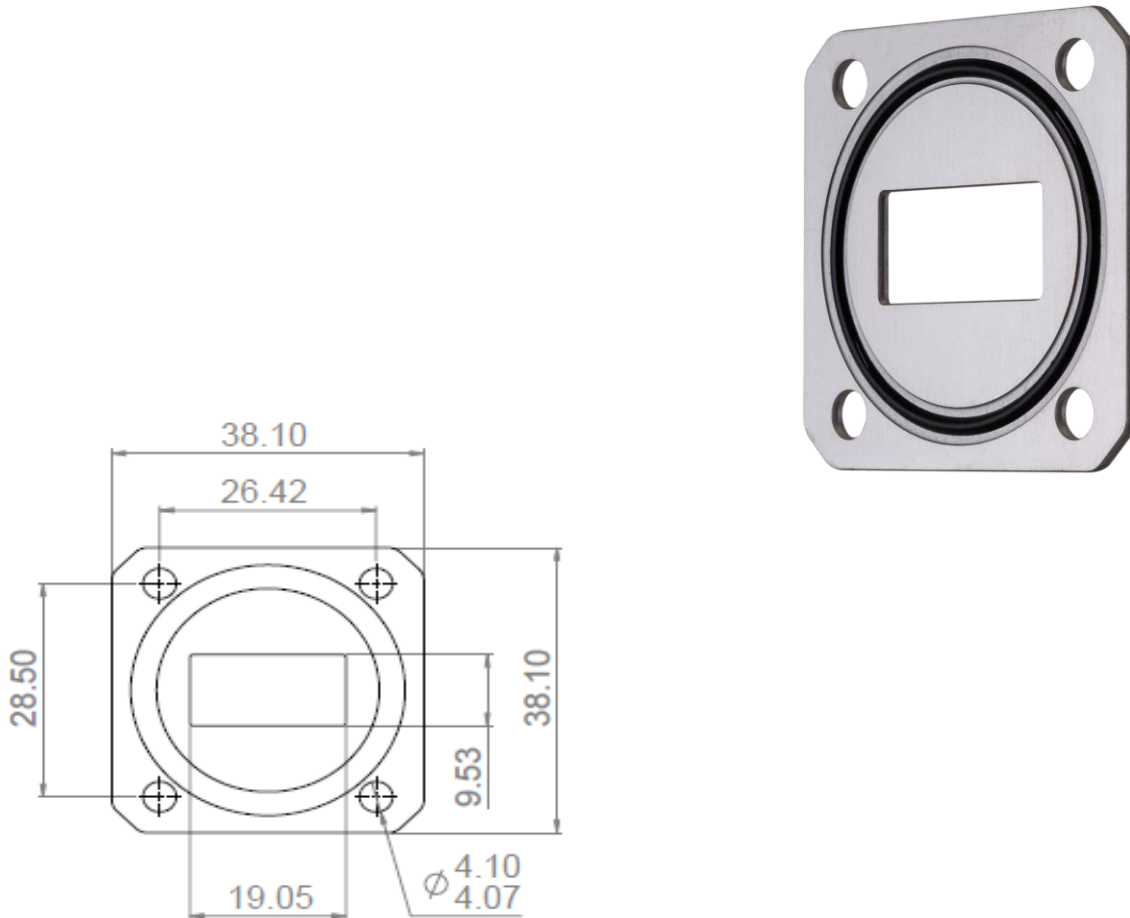

Part Number:	SS17K
Description	
Product Type:	Sealing Shim
Waveguide Size:	WG17 / WR75 / R120
Flange Face:	17K (PBR 120)
Material:	Stainless Steel
Thickness:	1.0 mm
Accessories:	None