

flexiguide

Product Specification

Sealing Shims - metal waveguide shims with integrated rubber gaskets on both sides. Used for connecting two flat flange faces together in a rectangular waveguide system to create a pressure tight/waterproof joint.

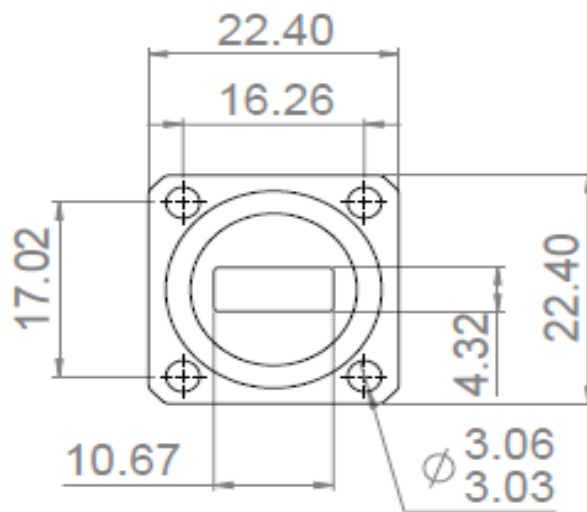

Part Number:

SS20K/Y

Description

Product Type:	Sealing Shim
Waveguide Size:	WG20 / WR42 / R220
Flange Face:	20K (PBR 220) / 20Y (UG 595/U + Groove)
Material:	Stainless Steel
Thickness:	1.0 mm
Accessories:	None